

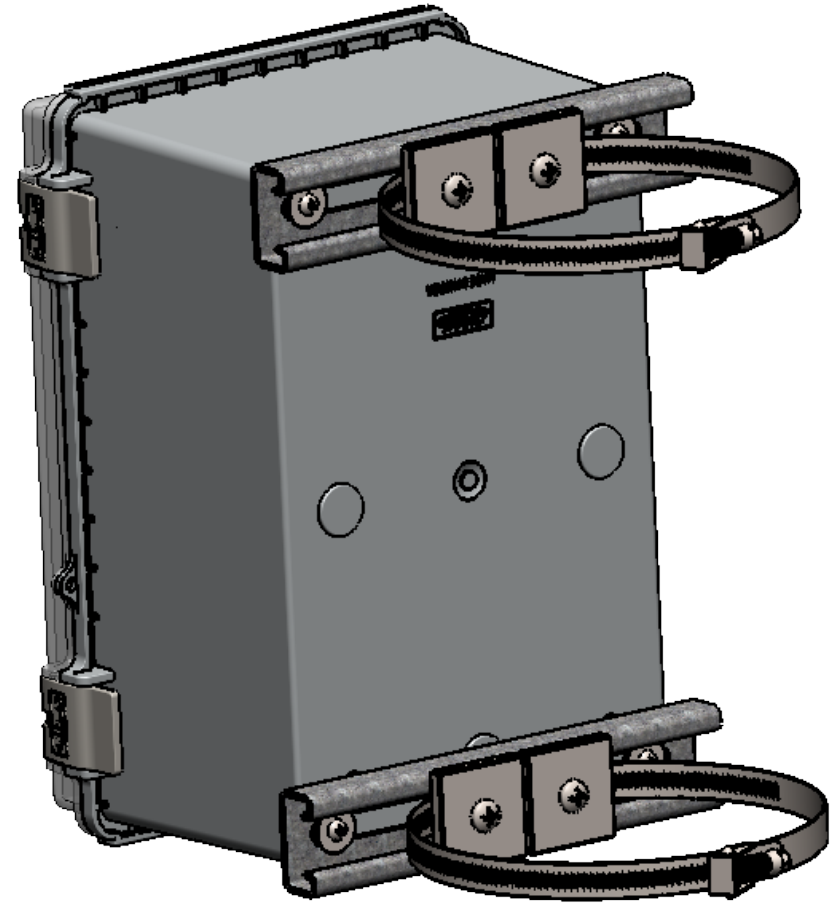

8 7 6 5 4 3 2 1

BOM Table					
ITEM NO.	PART NUMBER	Rev.	Description	Material	QTY.
1	WH-18-03	-	Hinged Nema Enclosure, Outdoor Use, with Flange Kit		1
2	PK-084	-.01	POLE MOUNT KIT		1
2.1	SC-080	-	Strut Channel P4100SLPG	PRE-GALV STEEL	2
2.2	SW-001	-	Strut Channel Washer 1/4	304 SST	4
2.3	SCREWS-031		CR PHMS 0.25-20x0.75	SST	4
2.4	W-002		WASHER #10 X .734 X .04	SST	4
2.5	SN-001	-	Strut Channel NUT 1/4-20	316 SST	4
2.6	CL-01	-	Hose Clamp, 2" to 12.25" ID, 35 in.-lbs. Max Torque	201 SST, ZINC SCREW	2
2.7	SCREWS-044	-	#8-16X1/2	SST	4

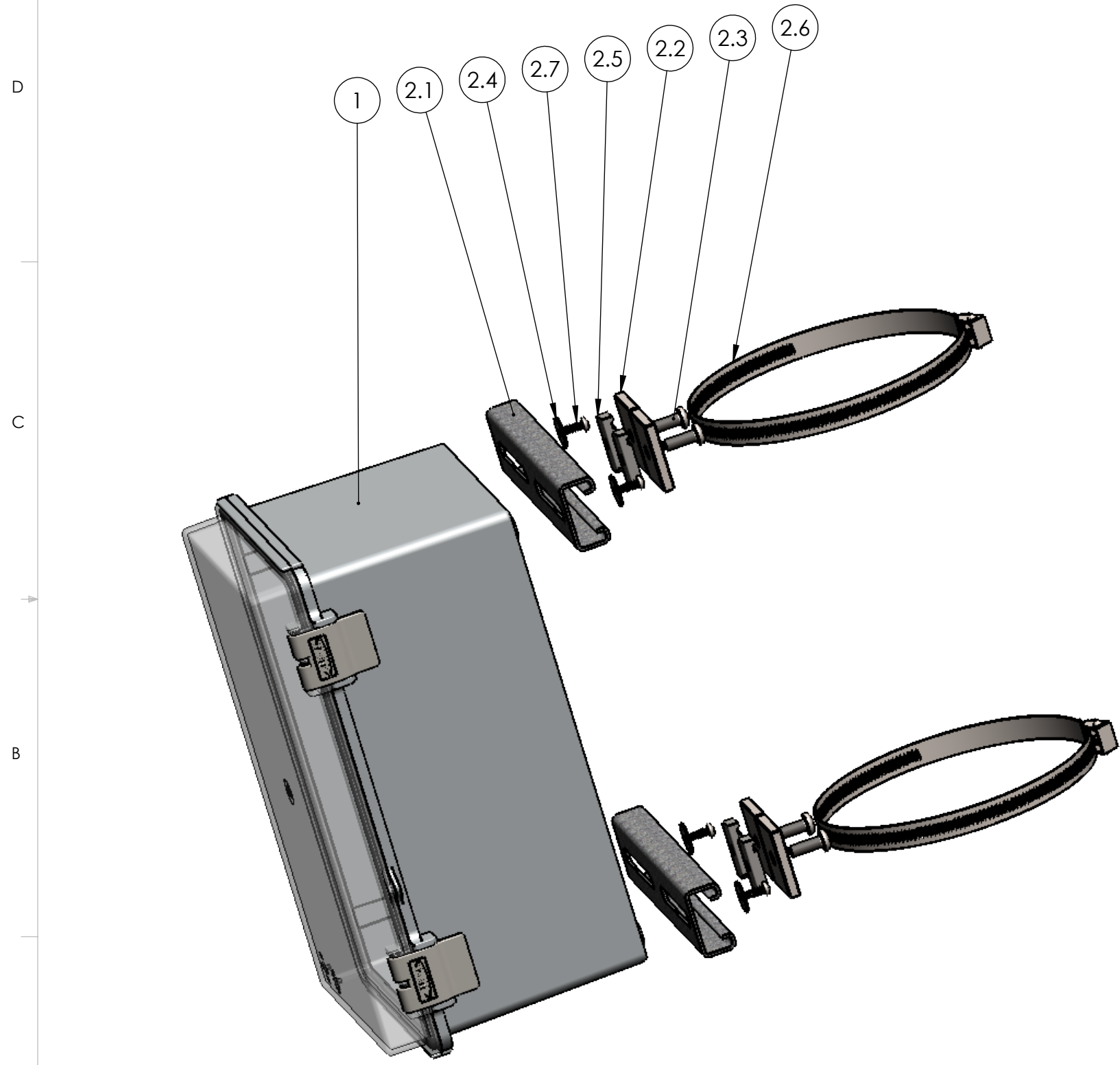

D
C
B
A

D
C
B
A

UNLESS OTHERWISE SPECIFIED: DIMENSIONS ARE IN: INCHES[mm] TOLERANCES: ANGULAR: ±2° TWO PLACE DECIMAL: ±.010 THREE PLACE DECIMAL: ±.005 PRINTED GRAPHICS: ±.010	PART NO. WH-18-PK		 <small>1305 CHESTER IND. PARKWAY AVON, OHIO 44011-1083 U.S.A. PH#: 1-800-248-1233, 440-934-0444 FAX#: 440-934-0088</small>												
	MATERIAL														
PROPRIETARY AND CONFIDENTIAL THE INFORMATION CONTAINED IN THIS DRAWING IS THE SOLE PROPERTY OF POLYCASE. ANY REPRODUCTION IN PART OR AS A WHOLE WITHOUT THE WRITTEN PERMISSION OF POLYCASE IS PROHIBITED. CAD FILE: WH-18-PK	FLAME RATING	SIZE B	REV -												
	DRAWN C.C.B.	NAME R.W.H.	DATE 10/20/2017	SCALE: 1:3											
<table border="1"> <thead> <tr> <th>REV.</th> <th>DESCRIPTION</th> <th>ZONE</th> <th>BY</th> <th>APPR'D</th> <th>DATE</th> </tr> </thead> <tbody> <tr> <td colspan="6" style="text-align: center;">REVISIONS</td> </tr> </tbody> </table>		REV.	DESCRIPTION	ZONE	BY	APPR'D	DATE	REVISIONS							SHEET 1 OF 3
REV.	DESCRIPTION	ZONE	BY	APPR'D	DATE										
REVISIONS															

8 7 6 5 4 3 2 1

8 7 6 5 4 3 2 1

D
C
B
A

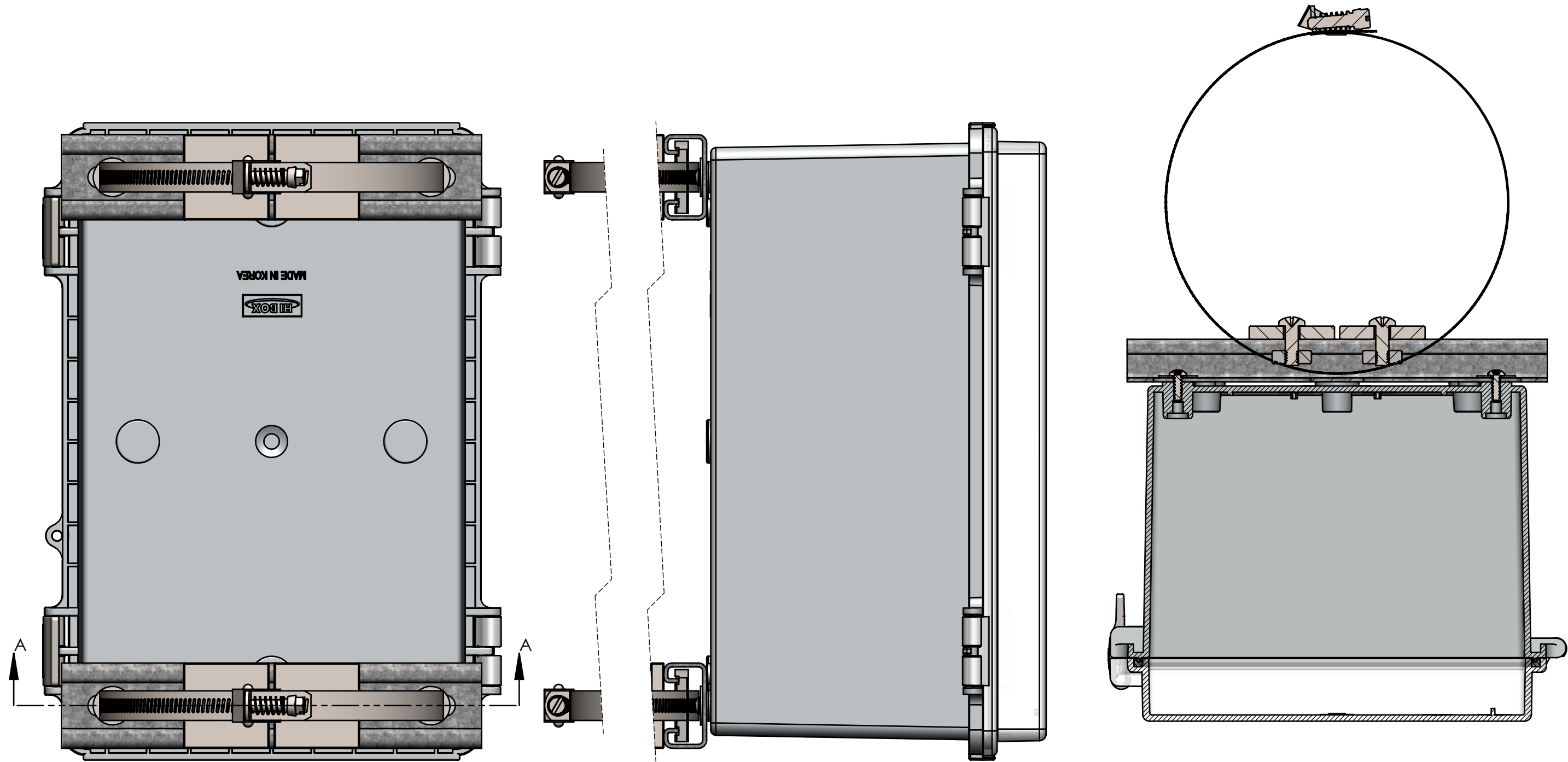

SECTION A-A

UNLESS OTHERWISE SPECIFIED:
 DIMENSIONS ARE IN: INCHES [mm]
 TOLERANCES: ANGULAR: ±2°
 TWO PLACE DECIMAL: ±.010
 THREE PLACE DECIMAL: ±.005
 PRINTED GRAPHICS: ±.010
 PROPRIETARY AND CONFIDENTIAL
 THE INFORMATION CONTAINED IN THIS
 DRAWING IS THE SOLE PROPERTY OF
 POLYCASE. ANY REPRODUCTION IN PART
 OR AS A WHOLE WITHOUT THE WRITTEN
 PERMISSION OF POLYCASE IS PROHIBITED.
 CAD FILE: WH-18-PK

PART NO. WH-18-PK		 <small>1305 CHESTER IND. PARKWAY AVON, OHIO 44011-1083 U.S.A. PH#: 1-800-248-1233, 440-934-0444 FAX#: 440-934-0088</small>
MATERIAL		
FLAME RATING	SIZE B	REV -
DRAWN R.W.H.	NAME C.C.B.	DATE 10/24/2017
CHECKED C.C.B.	DATE 10/20/2017	SCALE: 1:2

8 7 6 5 4 3 2 1

D
C
B
A

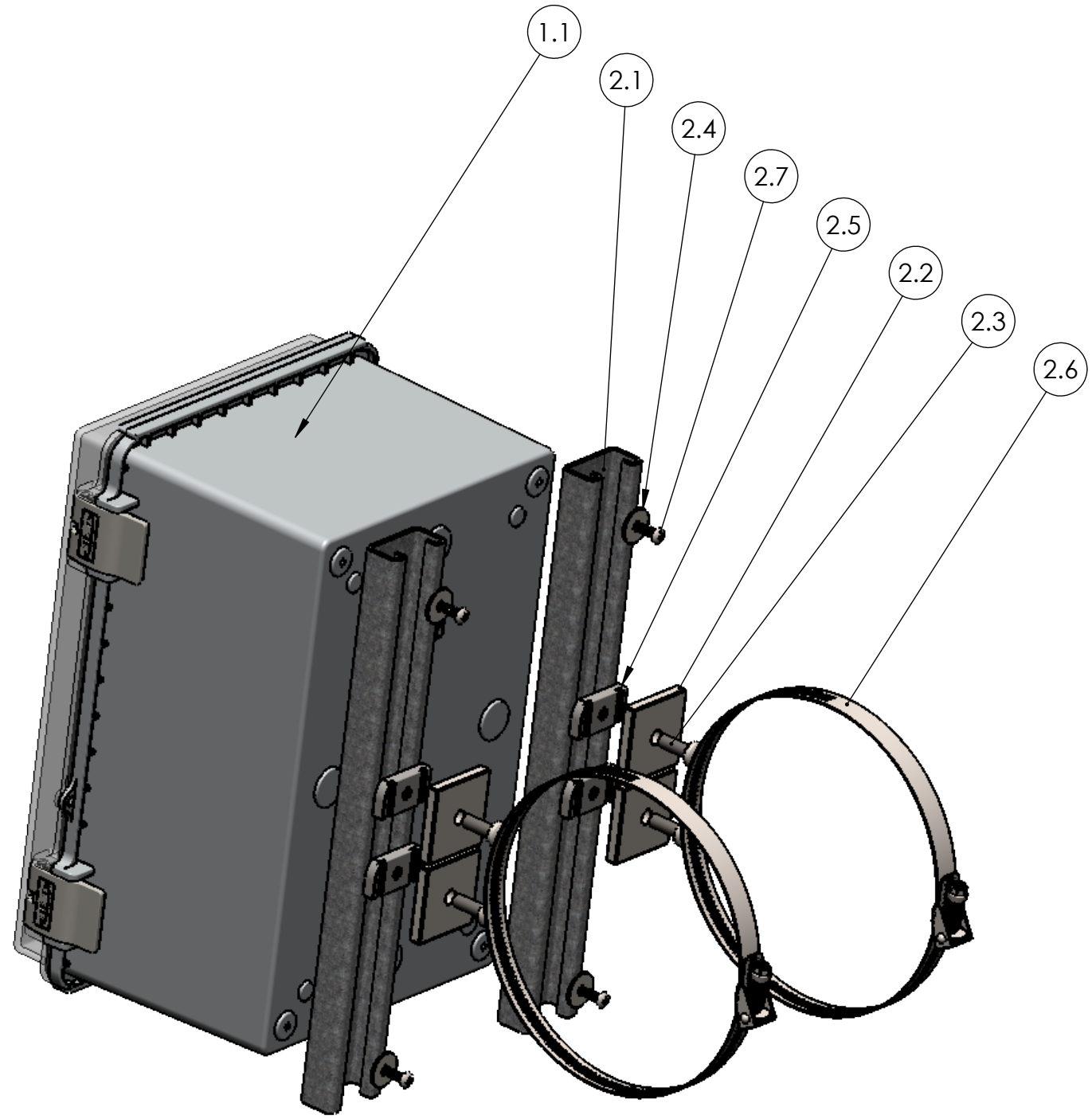

BOM Table					
ITEM NO.	PART NUMBER	Rev.	Description	Material	QTY.
1	WH-18-03	-	Hinged Nema Enclosure, Outdoor Use, with Flange Kit		1
1.1	WH-18S-03	-	Hinged Nema Enclosure- Outdoor Use		1
1.2	WH-91	-	WALL MTG. KIT		1
1.2.1	WH-91F	-	WALL MTG. FLANGE	STAINLESS STEEL	4
1.2.2	SCREWS-006	-.01	M5x1.59 X 10mm LG THREAD CUTTING, TRUSS HEAD SCREW	STEEL	4
2	PK-123	-.01	POLE MOUNT KIT		1
2.1	SC-120	-	Strut Channel P4100SLPG	PRE-GALV STEEL	2
2.2	SW-001	-	Strut Channel Washer 1/4	304 SST	4
2.3	SCREWS-031	-	CR PHMS 0.25-20x0.75	SST	4
2.4	W-002	-	WASHER #10 X .734 X .04	SST	4
2.5	SN-001	-	Strut Channel NUT 1/4-20	316 SST	4
2.6	CL-01	-	Hose Clamp, 2" to 12.25" ID, 35 in.-lbs. Max Torque	201 SST, ZINC SCREW	2
2.7	SCREWS-044	-	#8-16X1/2	SST	4

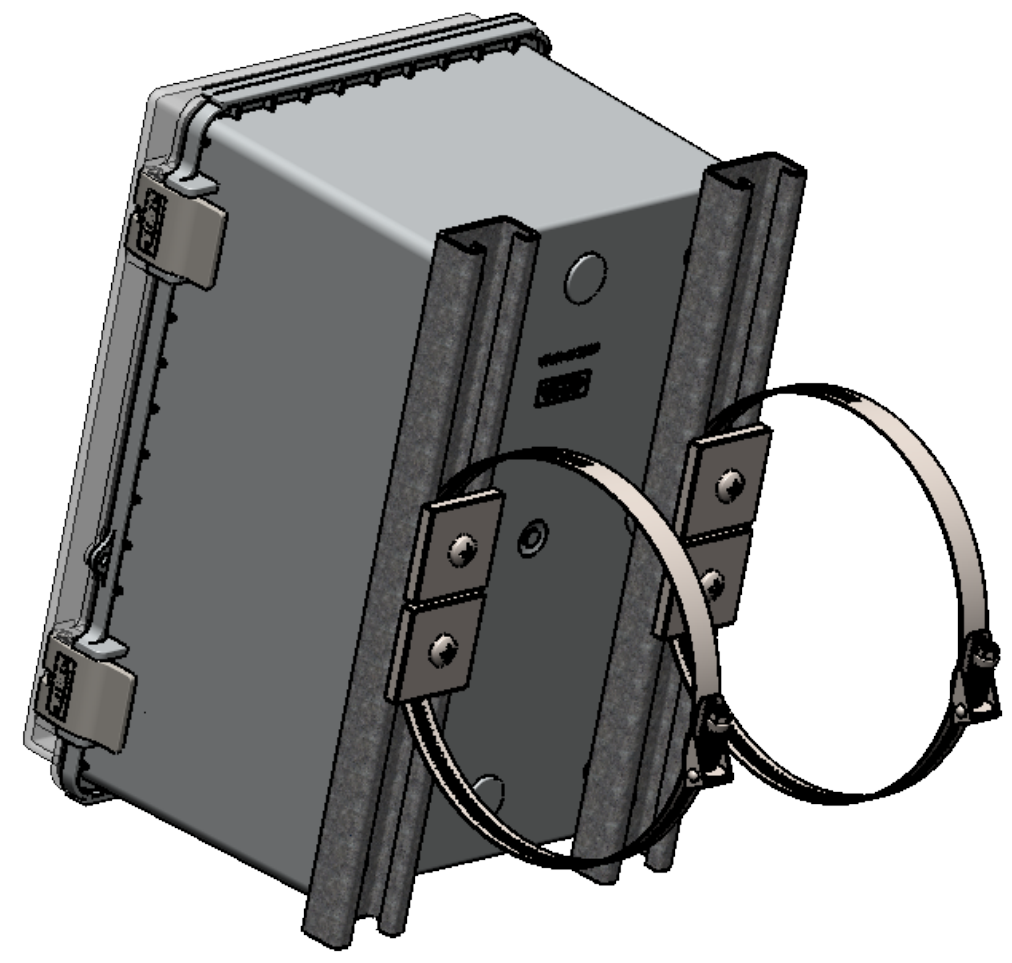

REV.	DESCRIPTION	ZONE	BY	APPR'D	DATE
REVISIONS					

UNLESS OTHERWISE SPECIFIED:
 DIMENSIONS ARE IN: INCHES[mm]
 TOLERANCES: ANGULAR: ±2°
 TWO PLACE DECIMAL: ±.010
 THREE PLACE DECIMAL: ±.005
 PRINTED GRAPHICS: ±.010

PROPRIETARY AND CONFIDENTIAL
 THE INFORMATION CONTAINED IN THIS
 DRAWING IS THE SOLE PROPERTY OF
 POLYCASE. ANY REPRODUCTION IN PART
 OR AS A WHOLE WITHOUT THE WRITTEN
 PERMISSION OF POLYCASE IS PROHIBITED.
 CAD FILE: WH-18-PK

PART NO.
 WH-18-PK
 MATERIAL

FLAME RATING

NAME	DATE
R.W.H.	10/20/2017
C.C.B.	10/24/2017

polycase
 1305 CHESTER IND. PARKWAY AVON, OHIO 44011-1083 U.S.A.
 PH#: 1-800-248-1233, 440-934-0444 FAX#: 440-934-0088

SIZE
B

REV
 -

SCALE: 1:3

SHEET 3 OF 3